

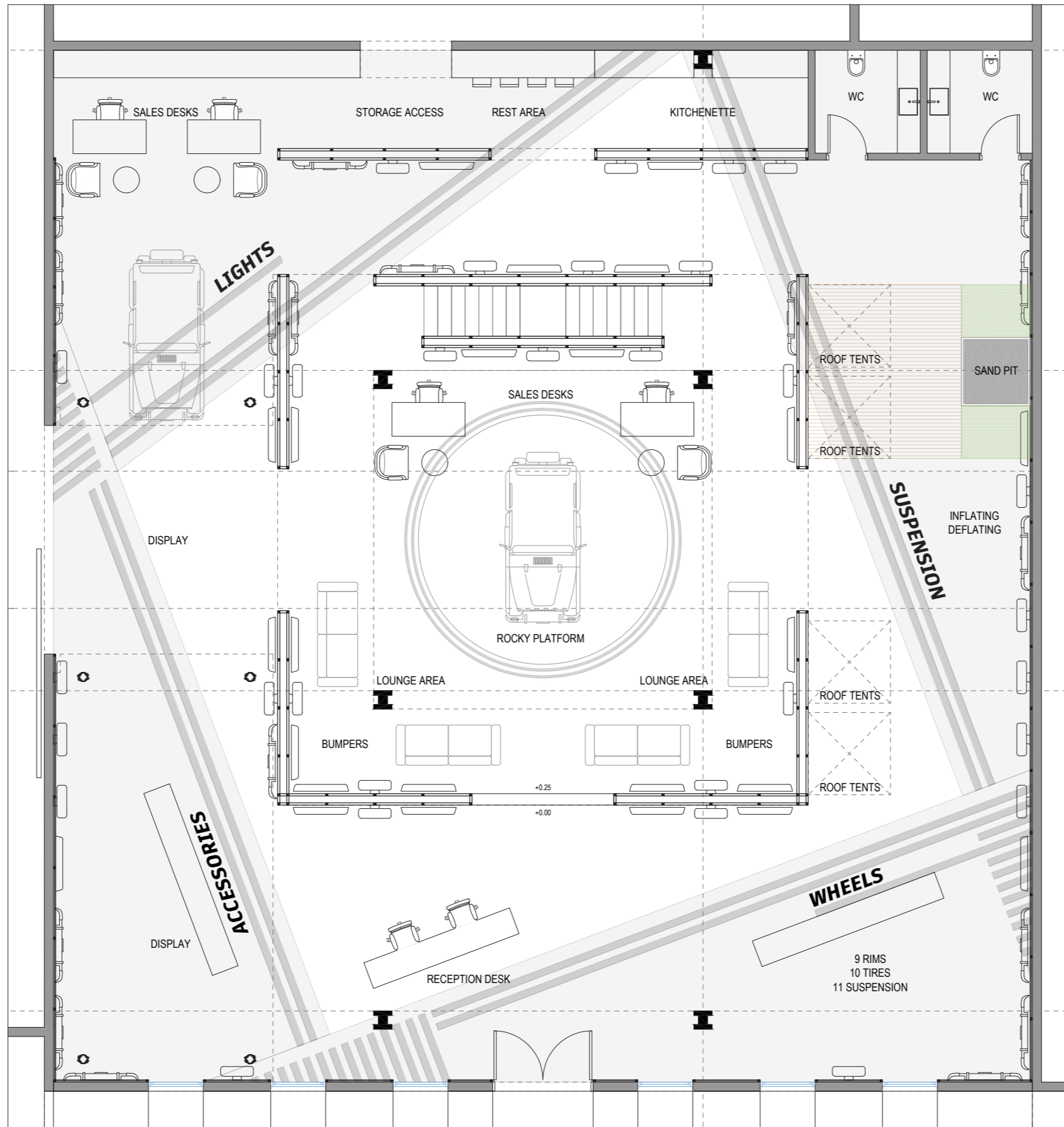

RAMY 4X4 SHOWROOM

CONCEPT DESIGN PROPOSAL



RAMY 4X4 SHOWROOM

CONCEPTUAL DESIGN

GROUND FLOOR PLAN

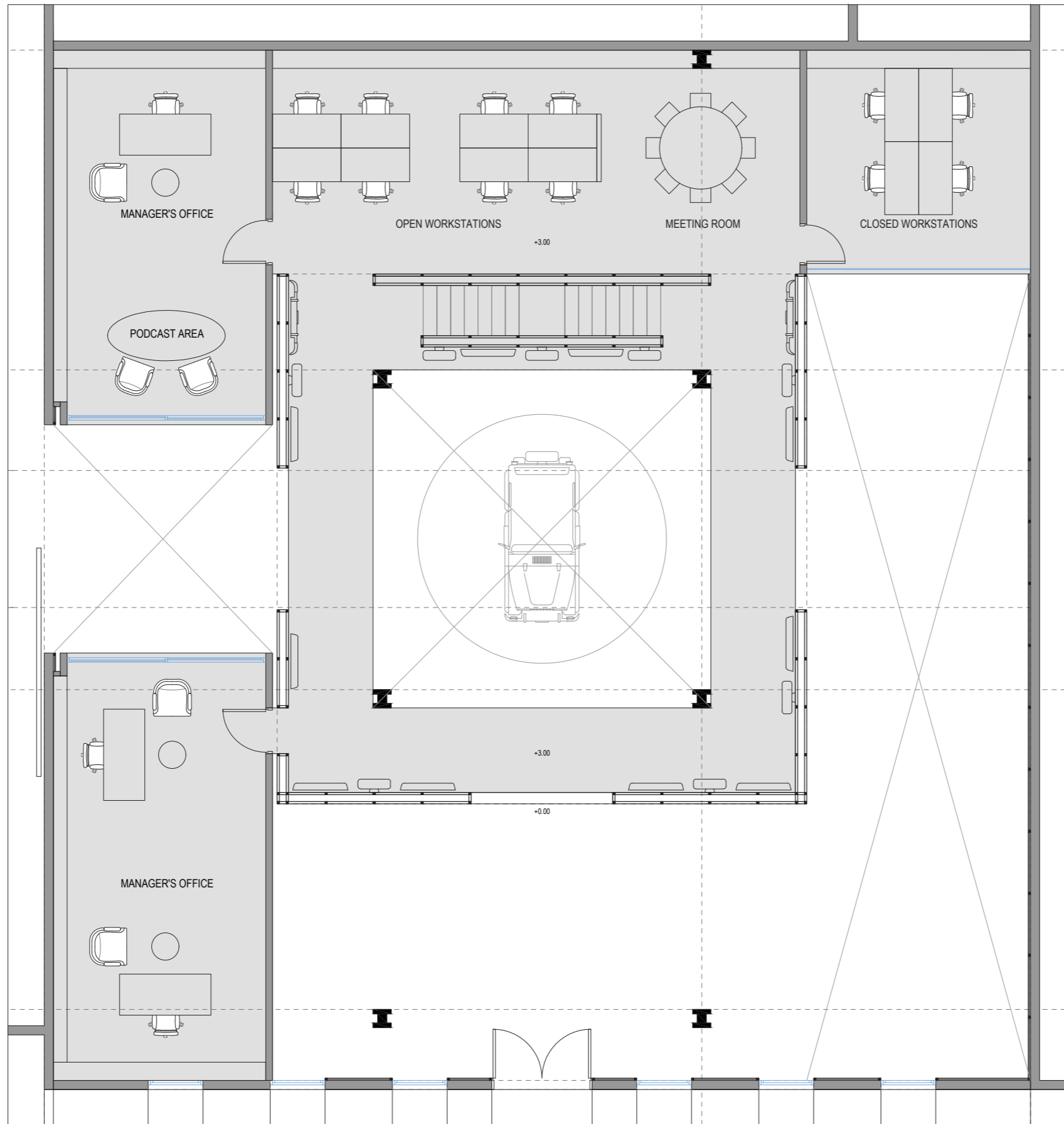

RAMY 4X4 SHOWROOM

CONCEPTUAL DESIGN

MEZZANINE FLOOR PLAN

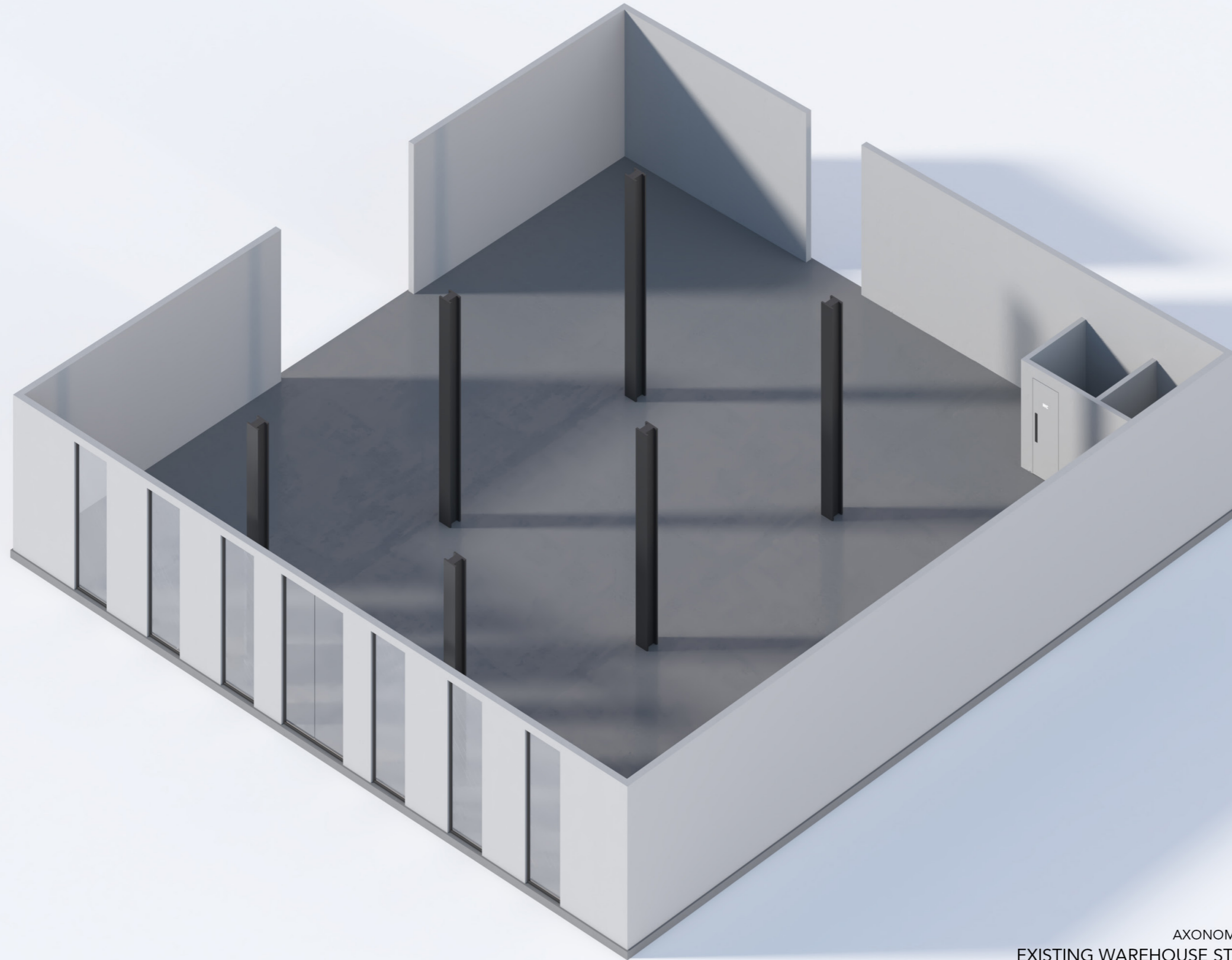

AXONOMETRIC VIEW
EXISTING WAREHOUSE STRUCTURE

RAMY 4X4 SHOWROOM

CONCEPTUAL DESIGN

AXONOMETRIC DIAGRAMS

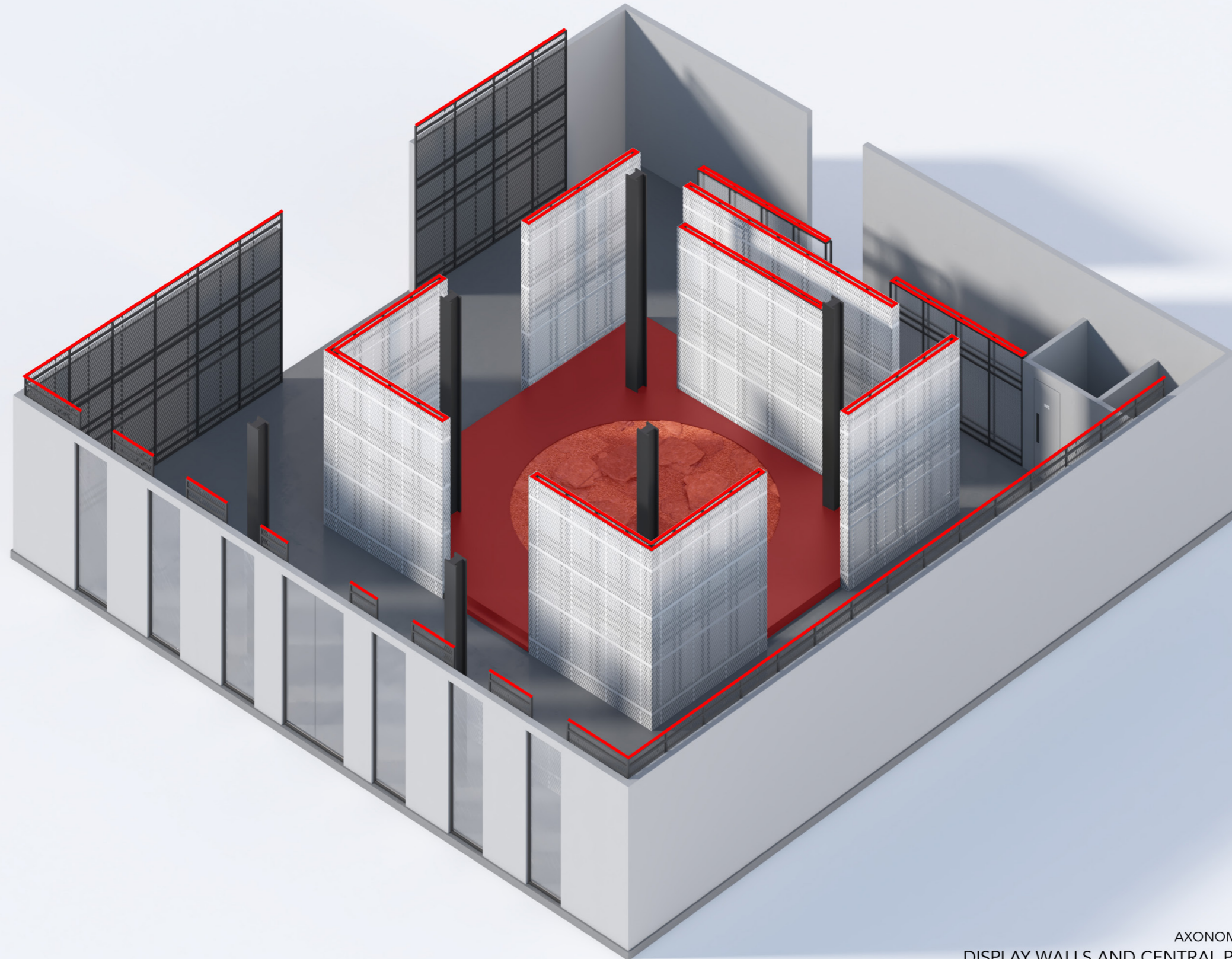

AXONOMETRIC VIEW
DISPLAY WALLS AND CENTRAL PLATFORM

RAMY 4X4 SHOWROOM

CONCEPTUAL DESIGN

AXONOMETRIC DIAGRAMS

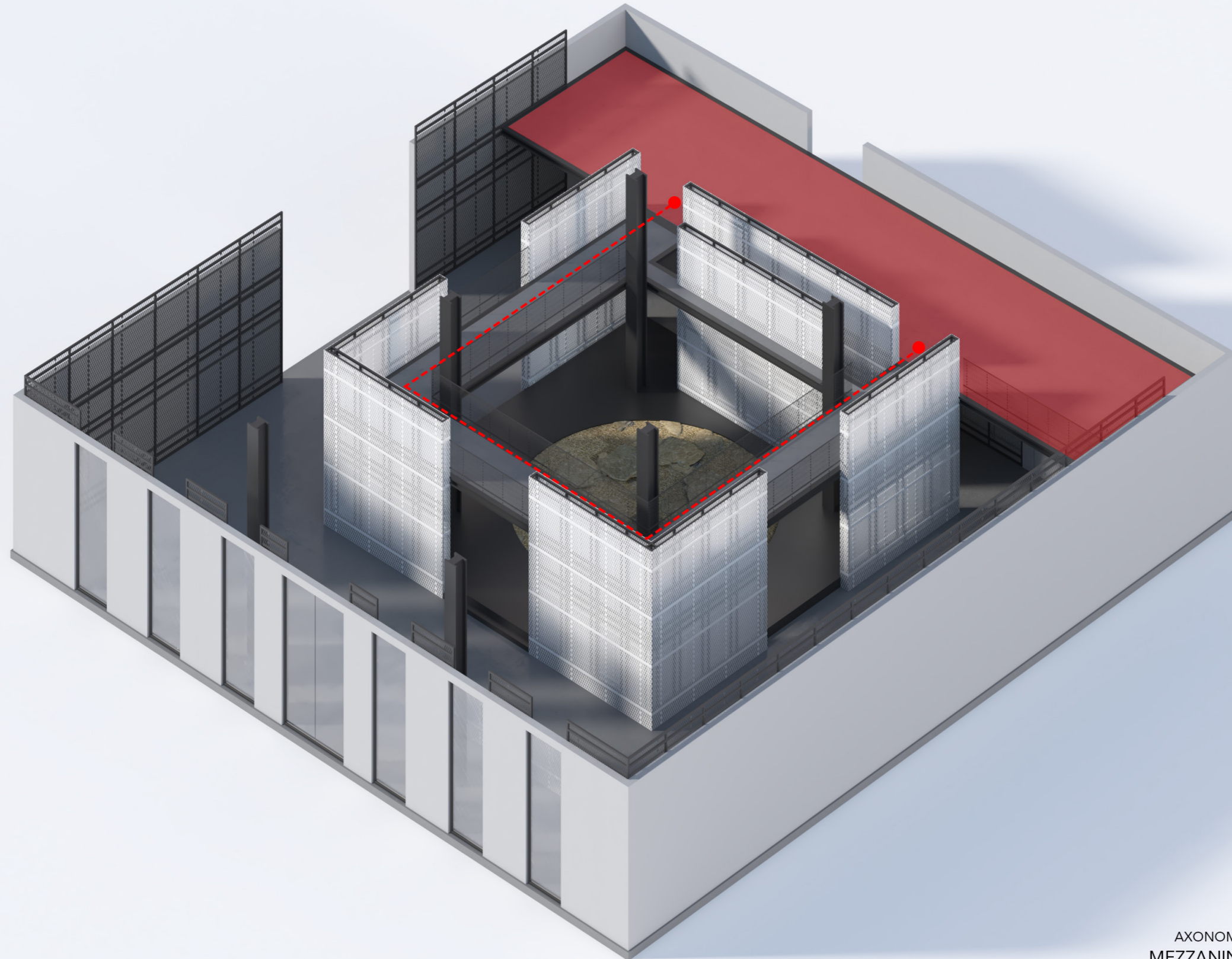

AXONOMETRIC VIEW
MEZZANINE FLOOR

RAMY 4X4 SHOWROOM

CONCEPTUAL DESIGN

AXONOMETRIC DIAGRAMS

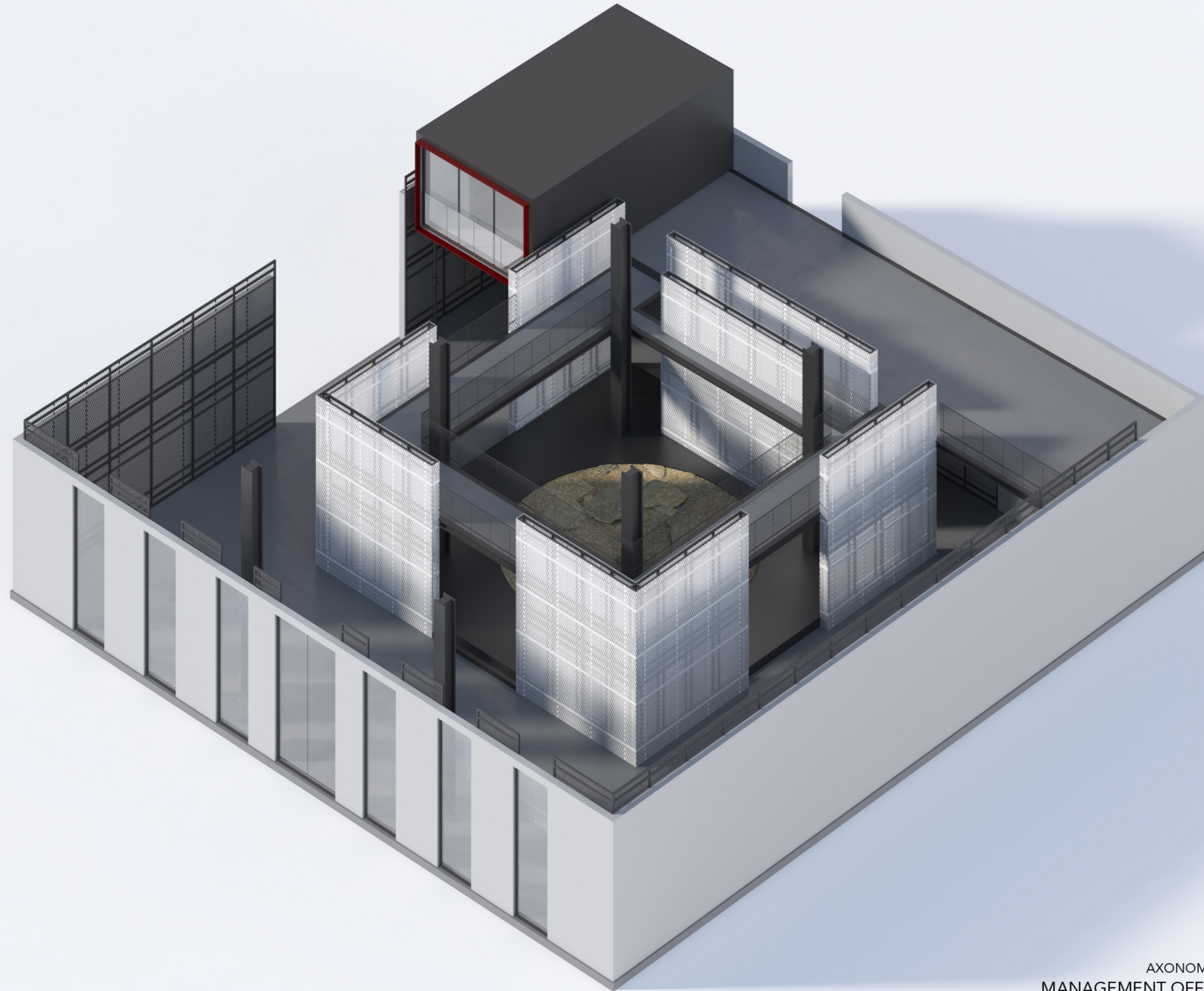

AXONOMETRIC VIEW
MANAGEMENT OFFICES BOX

RAMY 4X4 SHOWROOM

CONCEPTUAL DESIGN

AXONOMETRIC DIAGRAMS

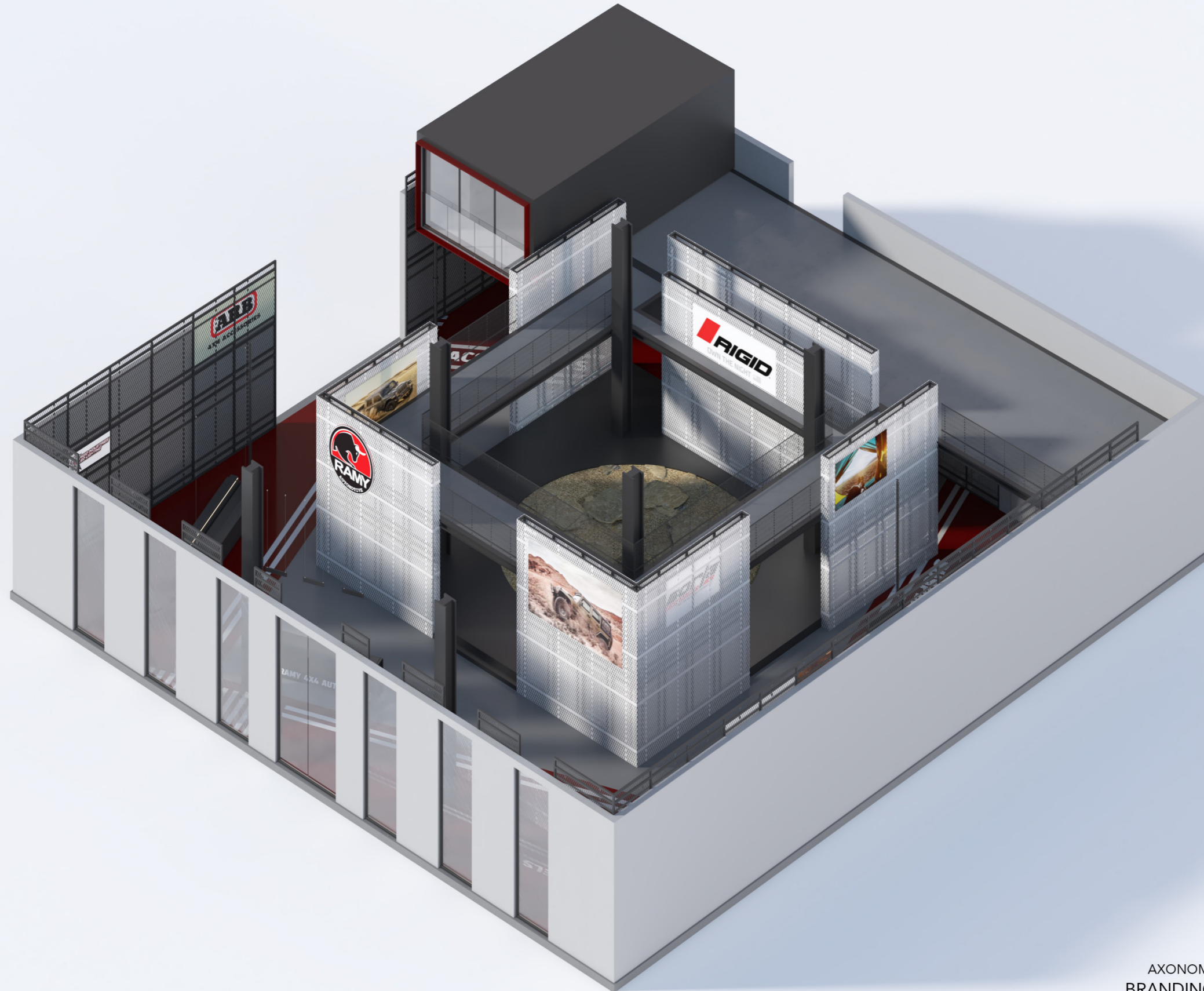

AXONOMETRIC VIEW
BRANDING DESIGN

RAMY 4X4 SHOWROOM

CONCEPTUAL DESIGN

AXONOMETRIC DIAGRAMS

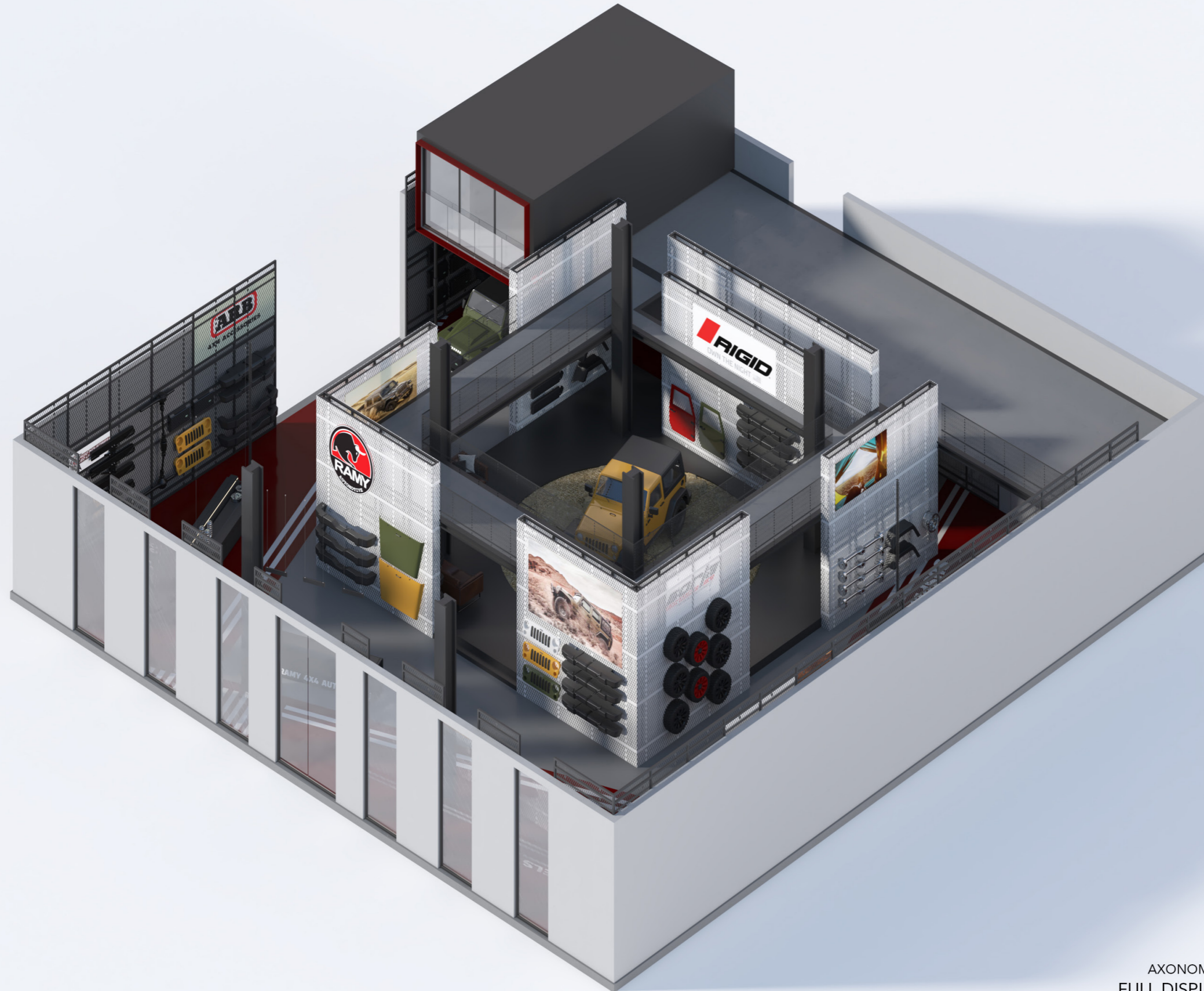

AXONOMETRIC VIEW
FULL DISPLAY MODE

RAMY 4X4 SHOWROOM

CONCEPTUAL DESIGN

AXONOMETRIC DIAGRAMS

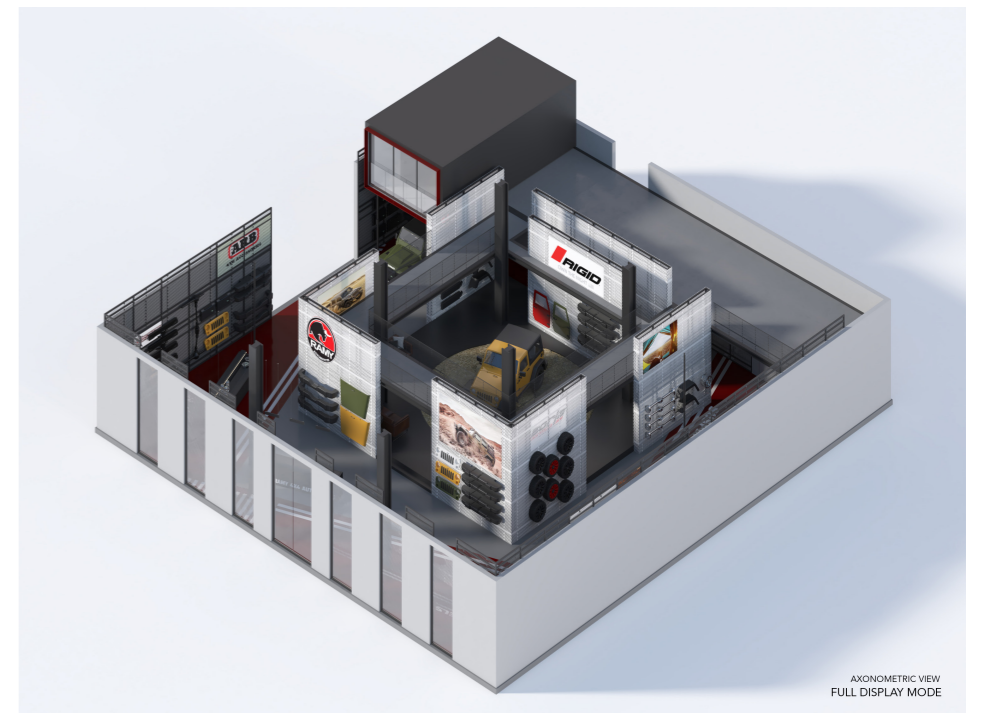
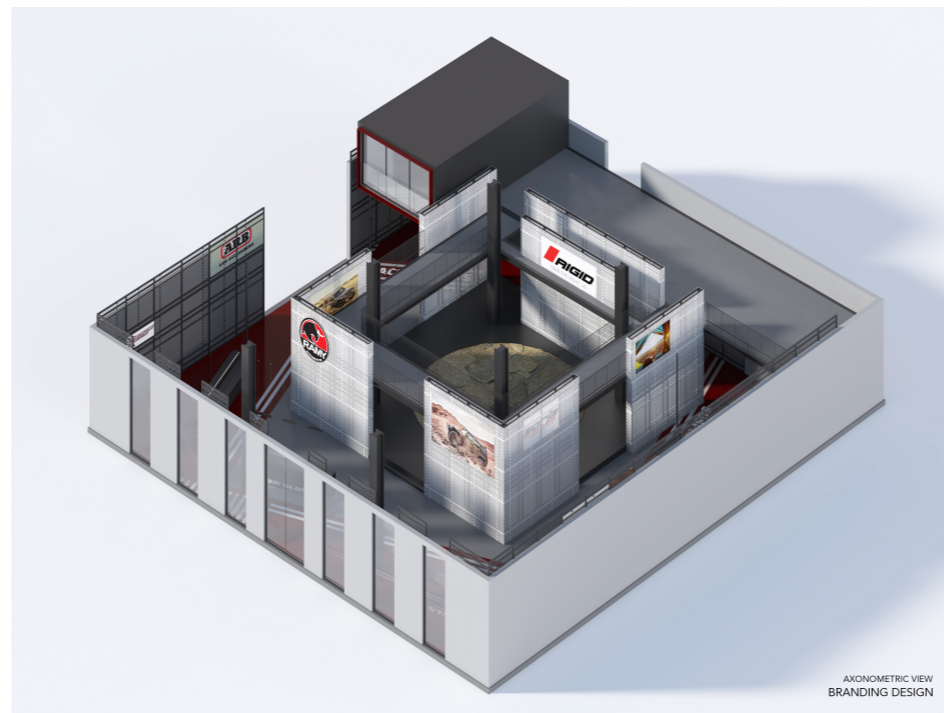
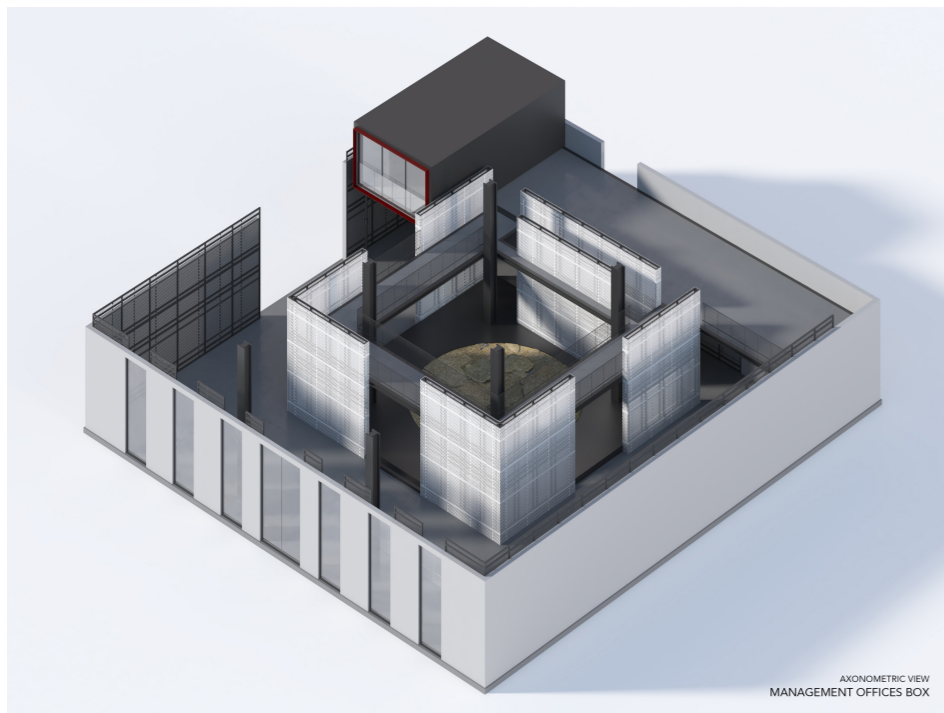
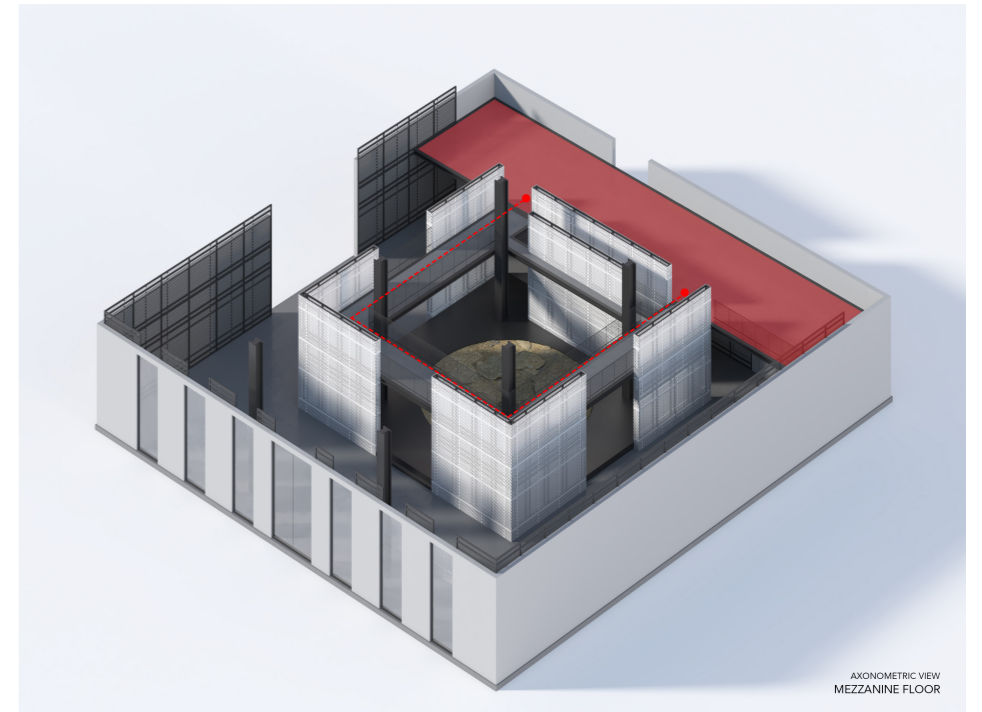
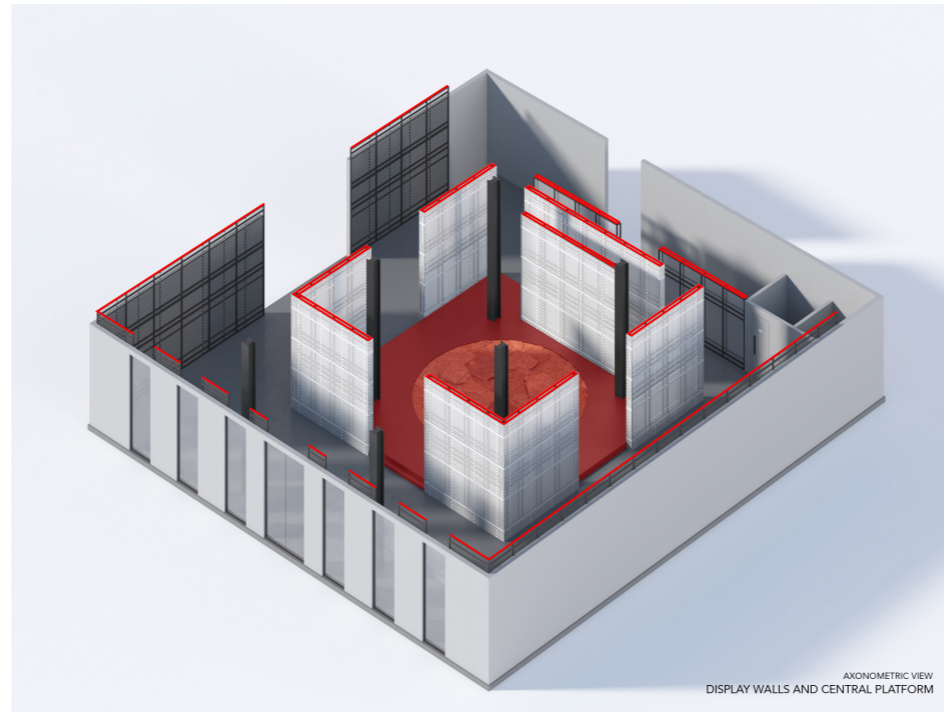
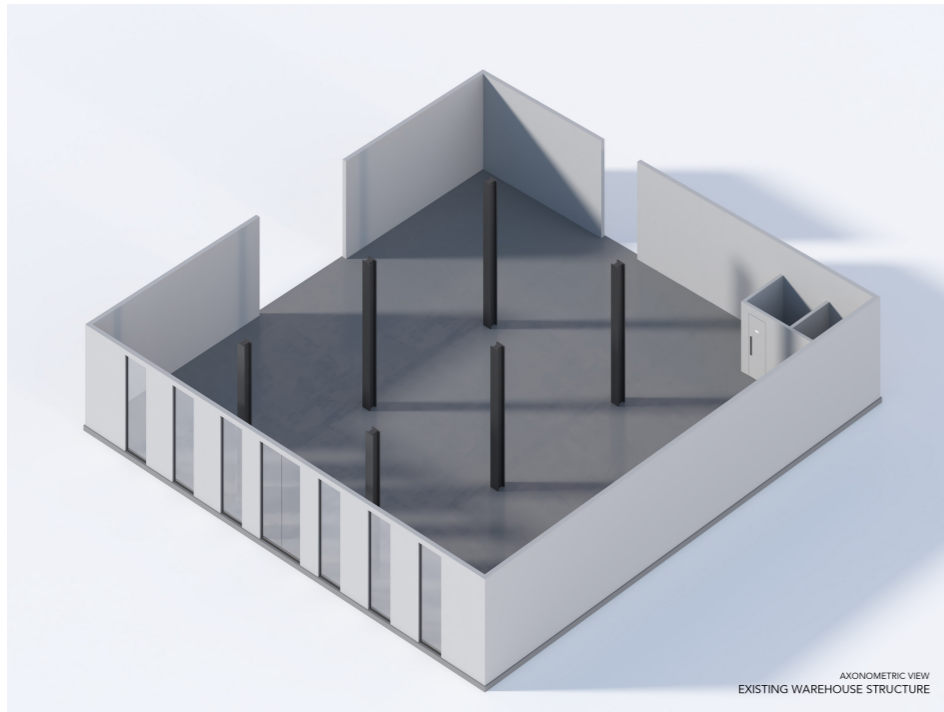

RAMY 4X4 SHOWROOM

CONCEPTUAL DESIGN

AXONOMETRIC DIAGRAMS

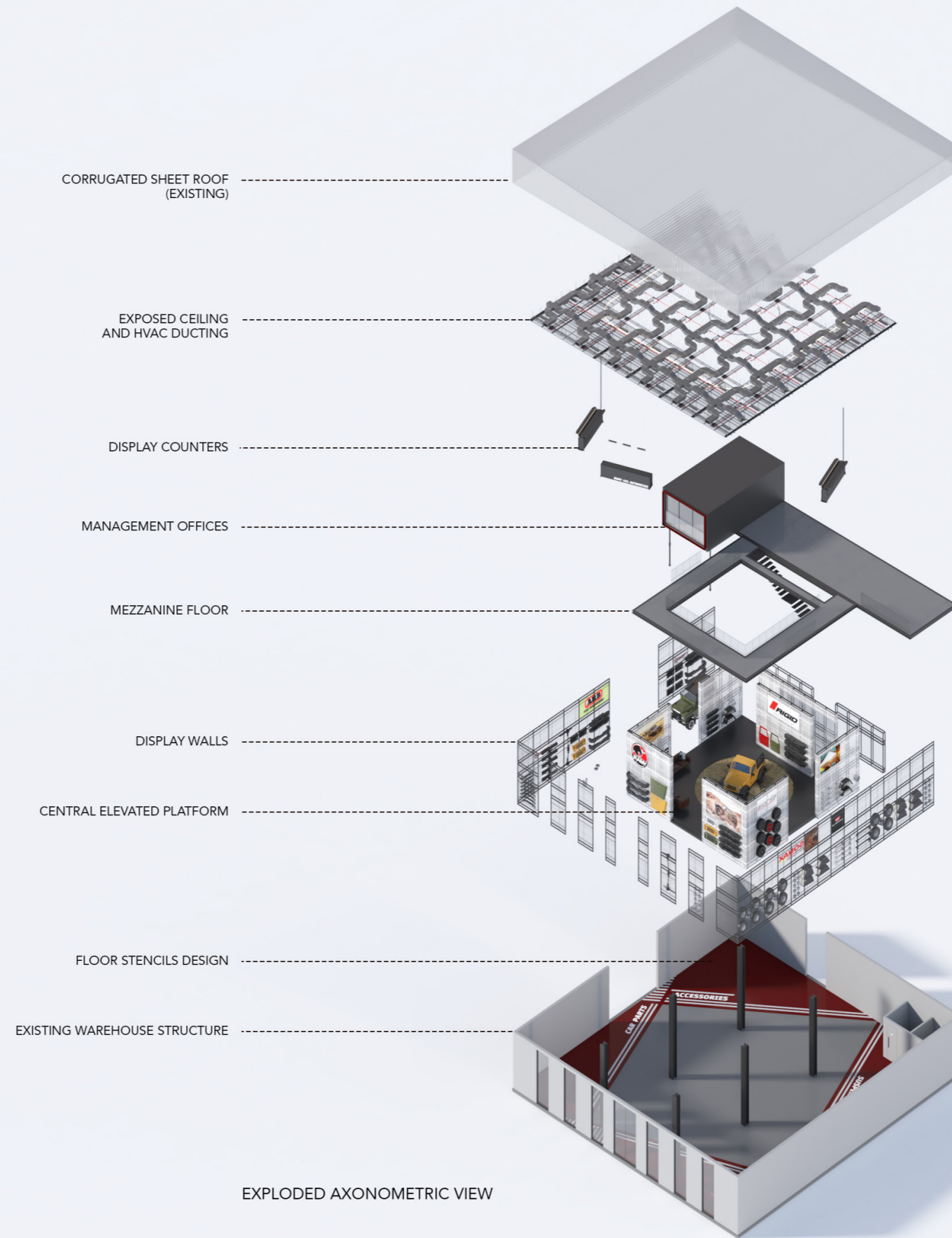

RAMY 4X4 SHOWROOM

CONCEPTUAL DESIGN

AXONOMETRIC DIAGRAMS



RAMY 4X4 SHOWROOM

CONCEPTUAL DESIGN

VIEW 01



RAMY 4X4 SHOWROOM

CONCEPTUAL DESIGN

VIEW 02



RAMY 4X4 SHOWROOM

CONCEPTUAL DESIGN

VIEW 03



RAMY 4X4 SHOWROOM

CONCEPTUAL DESIGN

VIEW 04

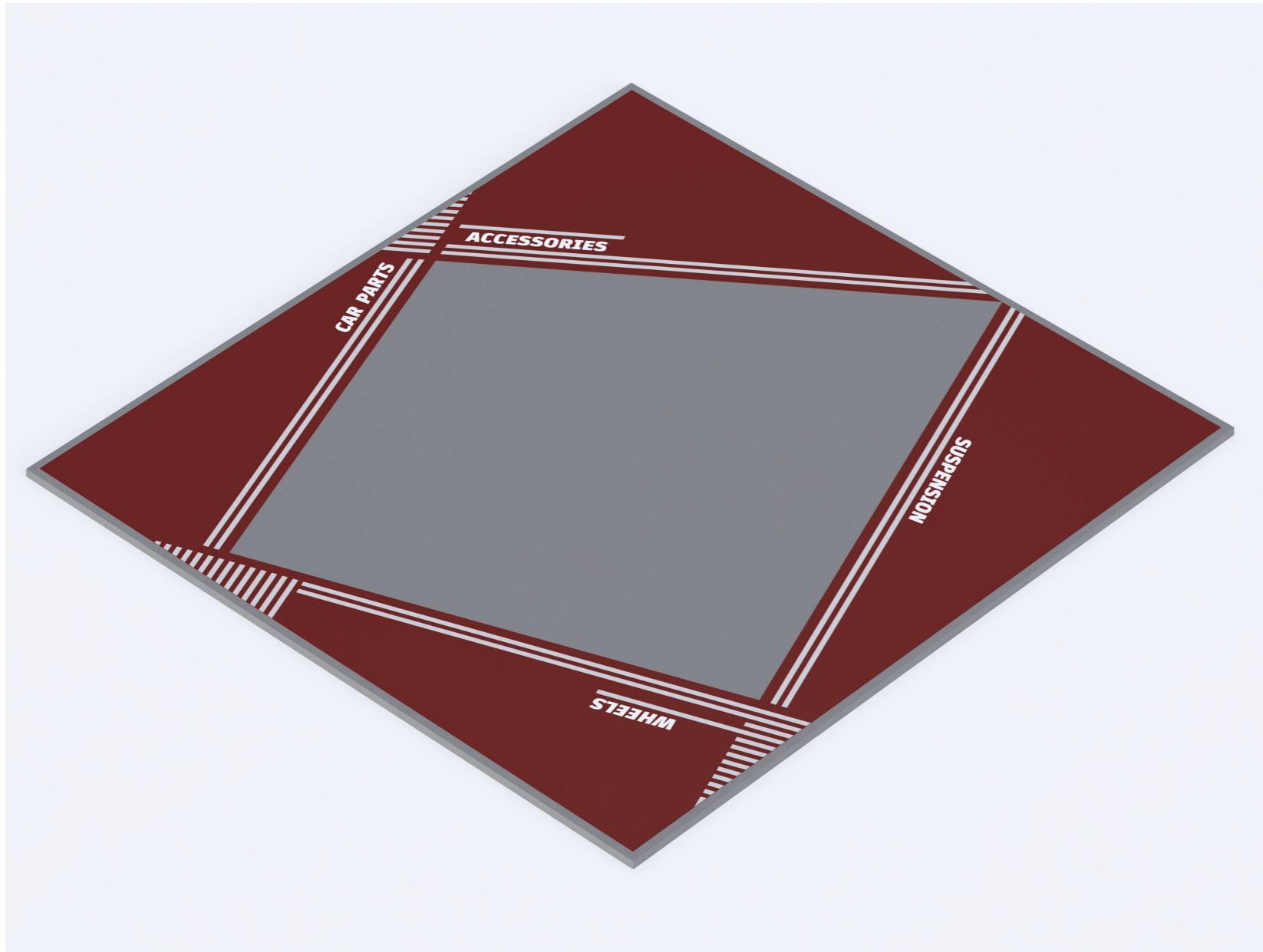

MAIN PLATFORM

STENCIL DESIGN ON THE FLOOR DIVIDE THE DISPLAY AREA INTO COMPARTMENTS BASED ON THEIR RESPECTIVE CONTENT.

RAMY 4X4 SHOWROOM

CONCEPTUAL DESIGN

INSTANCES DIAGRAMS

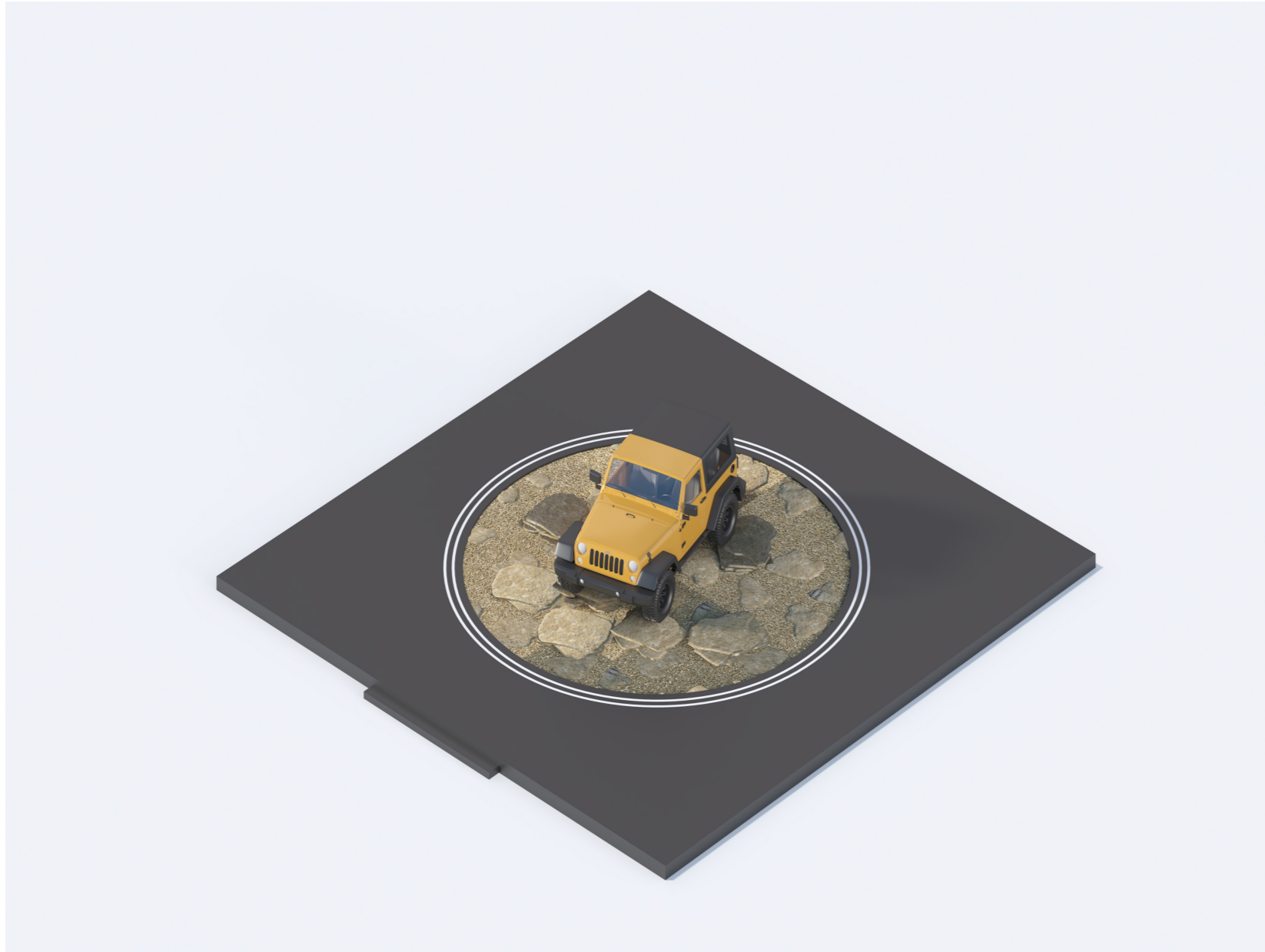

CENTRAL PLATFORM

CENTRAL PLATFORM DISPLAYS A PRIMARY MODIFIED CAR ON A ROUNDED SHAPE ROCKY FLOOR.

RAMY 4X4 SHOWROOM

CONCEPTUAL DESIGN

INSTANCES DIAGRAMS



CENTRAL PLATFORM + DISPLAY WALLS

DISPLAY WALLS SURROUND THE CENTRAL PLATFORM, PROVIDING AN IMMERSIVE INTERACTION FOR THE CUSTOMERS.

RAMY 4X4 SHOWROOM

CONCEPTUAL DESIGN

INSTANCES DIAGRAMS

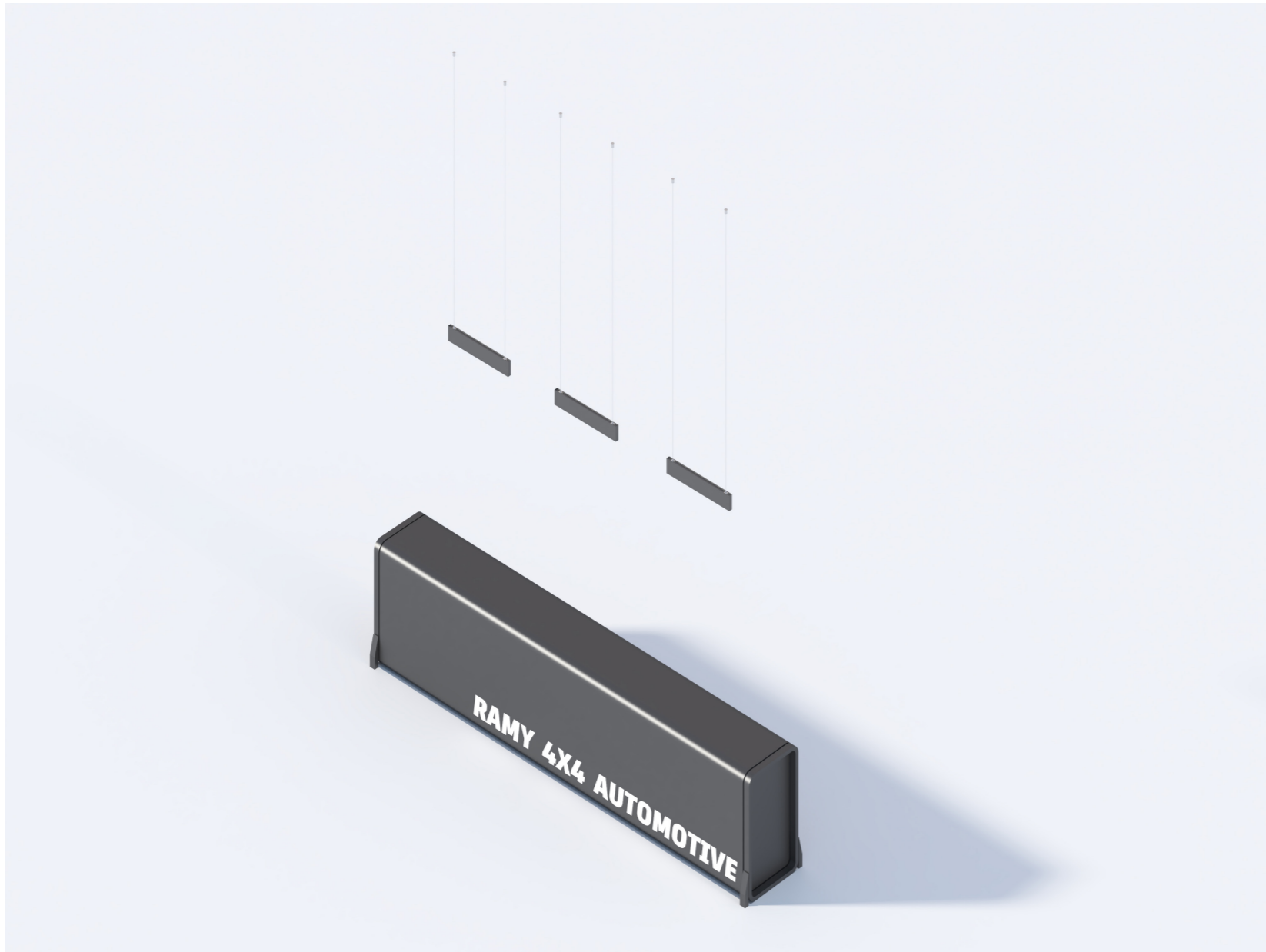

RECEPTION DESK

RECEPTION DESK, OFFERING SPACE FOR 2 RECEPTIONISTS.

RAMY 4X4 SHOWROOM

CONCEPTUAL DESIGN

INSTANCES DIAGRAMS

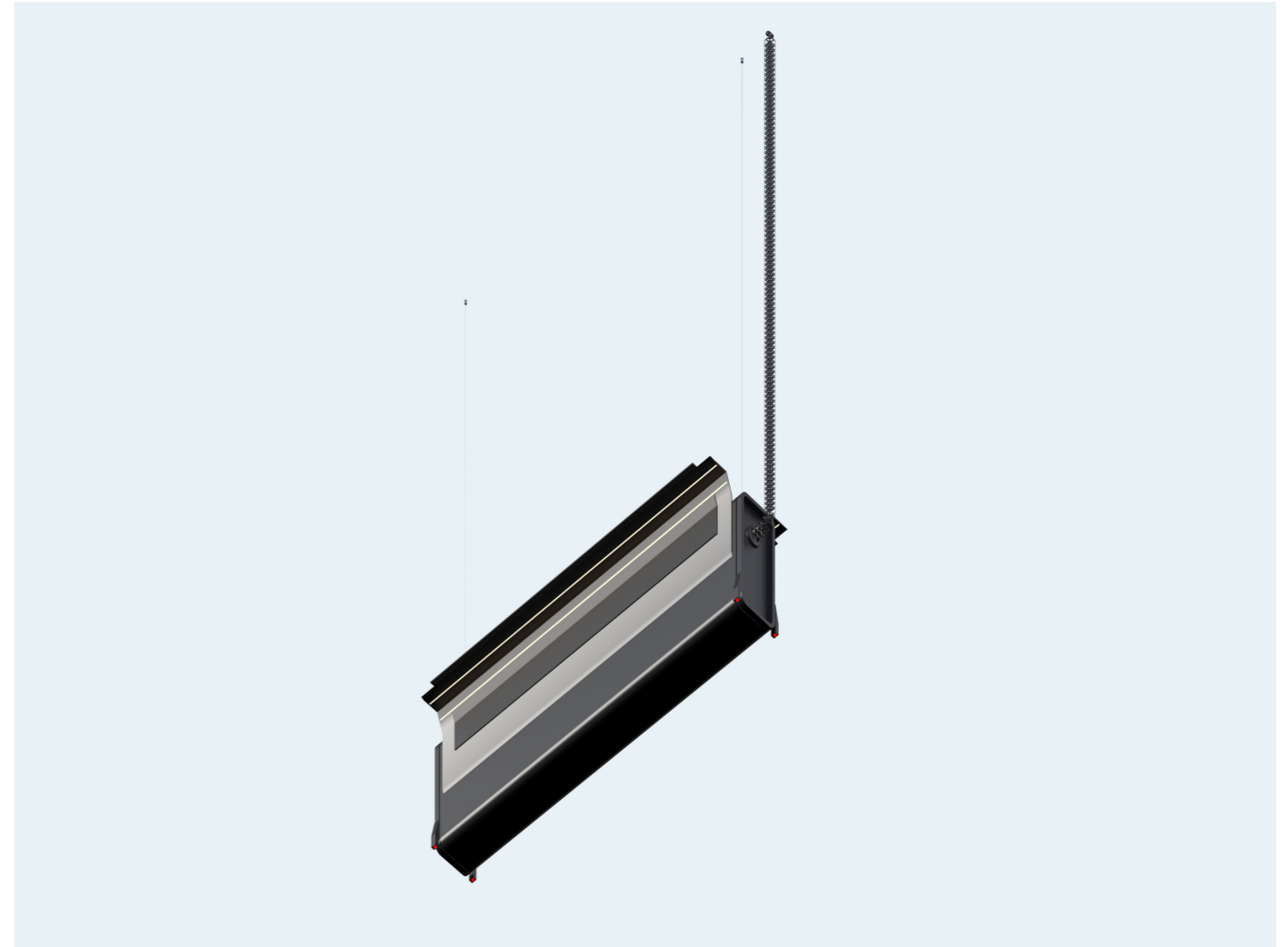
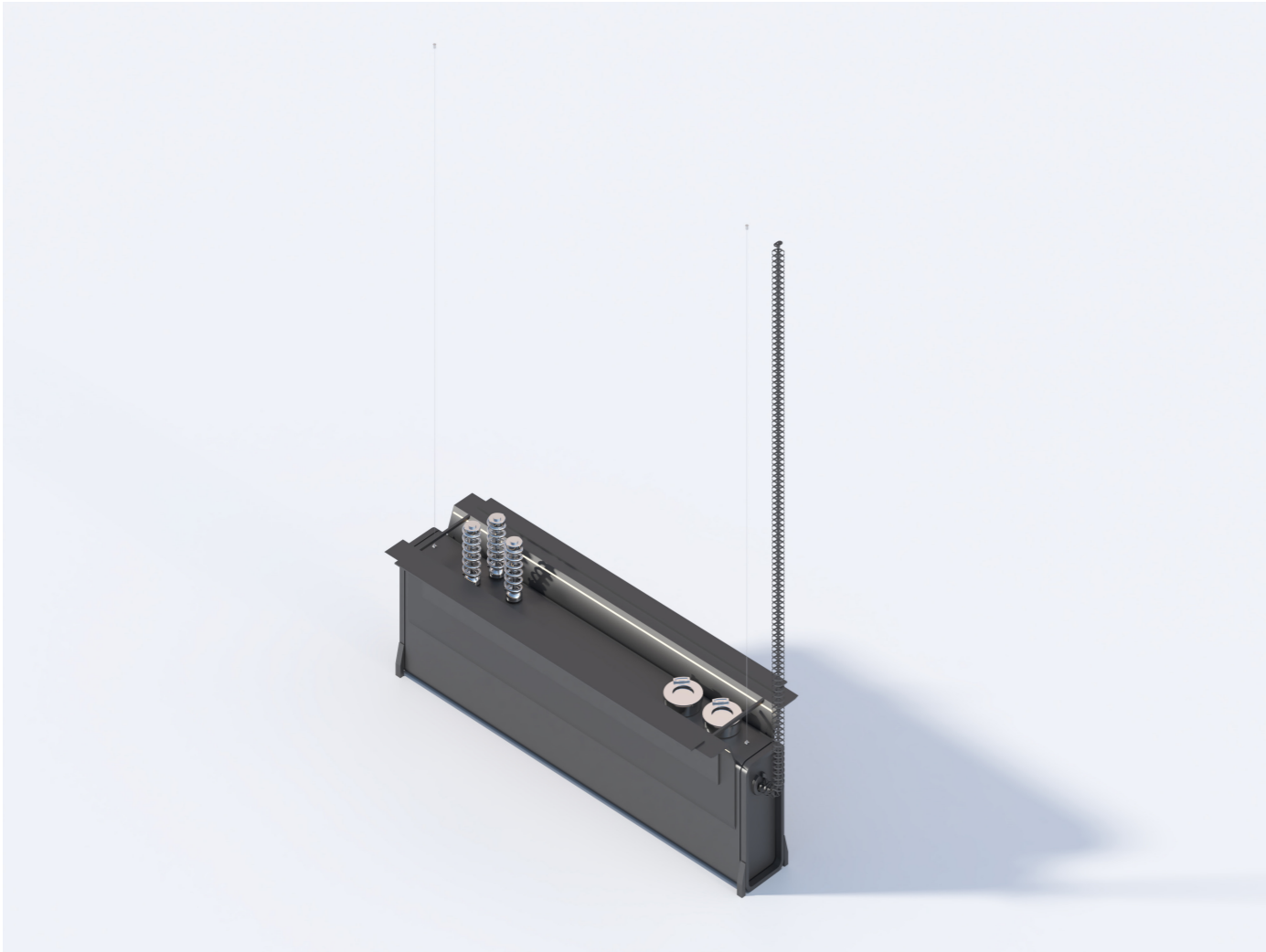

DISPLAY COUNTER

DISPLAY COUNTER DESIGN INSPIRED BY MECHANICAL MACHINERIES
SUSPENDED BY CABLES. ELECTRICAL CABLES ARE SUPPLIED FROM THE CEILING.

RAMY 4X4 SHOWROOM

CONCEPTUAL DESIGN

INSTANCES DIAGRAMS



RAM 4X4 AUTOMOTIVE

WHEELS